

Human TGF- β 2 ELISA

Product Data Sheet

Cat. No.: RBMS254R

For Research Use Only

CONTENTS

1.	INTENDED USE	3
2.	SUMMARY	3
3.	PRINCIPLES OF THE TEST	4
4.	REAGENTS PROVIDED	5
5.	STORAGE INSTRUCTIONS – ELISA KIT	6
6.	SPECIMEN COLLECTION AND STORAGE INSTRUCTIONS	6
7.	MATERIALS REQUIRED BUT NOT PROVIDED	6
8.	PRECAUTIONS FOR USE	7
9.	PREPARATION OF REAGENTS	8
10.	TEST PROTOCOL	9
11.	CALCULATION OF RESULTS	11
12.	LIMITATIONS	14
13.	PERFORMANCE CHARACTERISTICS	14
14.	REFERENCES	15
15.	REAGENT PREPARATION SUMMARY	16
16.	TEST PROTOCOL SUMMARY	17

**»» This kit is manufactured by:
BioVendor – Laboratorní medicína a.s.**

»» Use only the current version of Product Data Sheet enclosed with the kit!

1. INTENDED USE

The human TGF- β 2 ELISA is an enzyme-linked immunosorbent assay for the quantitative detection of human TGF- β 2. **The human TGF- β 2 ELISA is for research use only. Not for diagnostic or therapeutic procedures.**

2. SUMMARY

Transforming growth factor- β (TGF- β) belongs to a family of dimeric 25 kDa polypeptides that are ubiquitously distributed in tissues and synthesized by many different cells (6). Three isoforms of transforming Growth Factor- β (TGF-beta1, beta-2 and beta-3) exist in mammals. They play critical roles in growth regulation and development. Each isoform is encoded by a unique gene on different chromosomes. All three of these growth factors are secreted by most cell types, generally in a latent form, requiring activation before they can exert biological activity. The TGF-betas possess three major activities: they inhibit proliferation of most cells, but can stimulate the growth of some mesenchymal cells; they exert immunosuppressive effects and they enhance the formation of extracellular matrix. Two types of membrane receptors possessing kinase activity are involved in signal transduction. The TGF-betas are involved in wound repair processes and in starting inflammatory reaction and then in the resolution through chemotactic attraction of inflammatory cells and fibroblast (7).

Contrary to TGF- β 1, TGF- β 2 is not produced by blood platelets. TGF- β 2 is a potent cytokine which has been shown to modulate embryonic development, bone formation, mammary development, wound healing, hematopoiesis, cell cycle progression and the production of the extracellular matrix. TGF- β 2 – null mice were shown to exhibit perinatal mortality and a wide range of developmental defects for a single gene description which include cardiac, lung, craniofacial, limb, spinal column, eye, inner ear and urogenital defects (9).

TGF- β 2 has been shown to be a potent growth inhibit factor of uveal melanocytes (4). It has been described as a factor in the regulation of postnatal cerebellar neurons and neuroblast proliferation (1).

TGF- β 2 has been detected in tear fluid (2). TGF- β 2 levels are elevated in the vitreous of patients with proliferative diabetic retinopathy (3). Elevated plasma levels of TGF- β 2 have been described in patients with disseminated malignant melanoma (5). TGF- β 2 concentrations are furthermore elevated in Parkinson's disease in ventricular cerebrospinal fluid (10).

In laboratory animals TGF- β 2 was shown to reduce the number of gonocytes by increasing apoptosis (8).

3. PRINCIPLES OF THE TEST

An anti-human TGF- β 2 coating antibody is adsorbed onto microwells. Figure 1

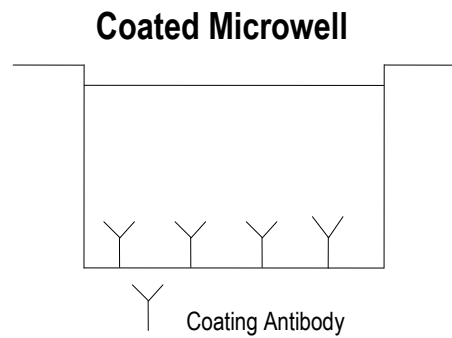

Human TGF- β 2 present in the sample or standard binds to antibodies adsorbed to the microwells. Figure 2

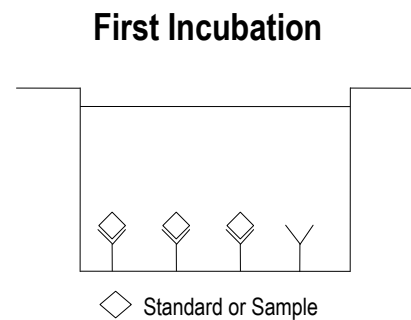

Following incubation unbound biological components are removed during a wash step. A biotin-conjugated anti-human TGF- β 2 antibody is added and binds to human TGF- β 2 captured by the first antibody. Figure 3

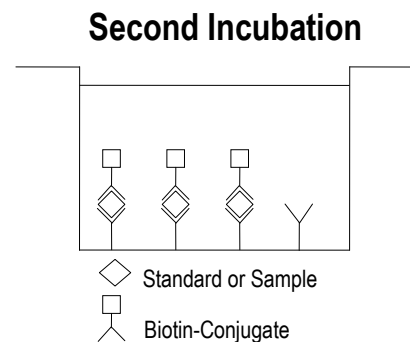

Following incubation unbound biotin-conjugated anti-human TGF- β 2 antibody is removed during a wash step. Streptavidin-HRP is added and binds to the biotin-conjugated anti-human TGF- β 2 antibody. Figure 4

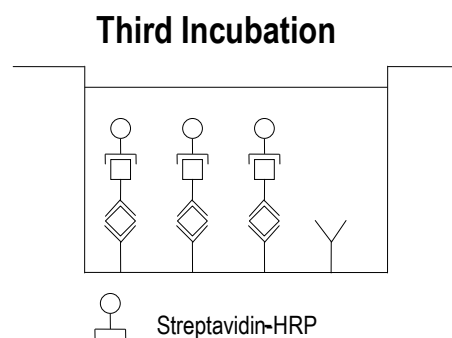

Following incubation unbound Streptavidin-HRP is removed during a wash step, and substrate solution reactive with HRP is added to the wells.

Figure 5

Fourth Incubation

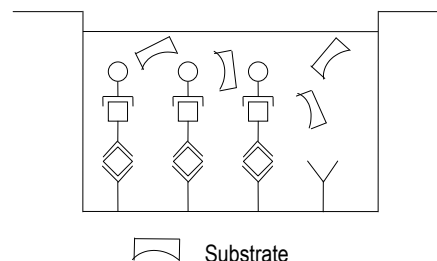

A coloured product is formed in proportion to the amount of human TGF- β 2 present in the sample or standard. The reaction is terminated by addition of acid and absorbance is measured at 450 nm. A standard curve is prepared from 6 human TGF- β 2 standard dilutions and human TGF- β 2 sample concentration determined.

Figure 6

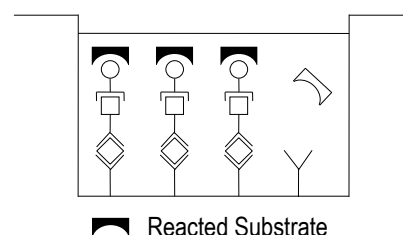

4. REAGENTS PROVIDED

- 1 aluminium pouch with a **Antibody Coated Microtiter Strips** with monoclonal antibody to human TGF- β 2
- 1 vial (11 ml) **Biotin-Conjugate** anti-human TGF- β 2 monoclonal antibody
- 1 vial (11 ml) **Streptavidin-HRP**
- 1 vial (2 ml) human TGF- β 2 **Standard**, 1000 pg/ml
- 1 vial (2 ml) **1 N HCl** (pretreatment of samples)
- 1 vial (2 ml) **1N NaOH** (pretreatment of samples)
- 1 vial (10 ml) **Assay Buffer Concentrate** 10x
- 1 bottle (30 ml) **Wash Buffer Concentrate** 40x
- 1 vial (11 ml) **Substrate Solution** (tetramethyl-benzidine)
- 1 vial (6 ml) **Stop Solution** (0.5M H₂SO₄)
- 6 **Adhesive Films**

5. STORAGE INSTRUCTIONS – ELISA KIT

Store kit reagents between 2° and 8°C. Immediately after use remaining reagents should be returned to cold storage (2° to 8°C). Expiry of the kit and reagents is stated on labels.

Expiry of the kit components can only be guaranteed if the components are stored properly, and if, in case of repeated use of one component, this reagent is not contaminated by the first handling.

6. SPECIMEN COLLECTION AND STORAGE INSTRUCTIONS

Cell culture supernatant (without serum components) and serum were tested with this assay. Other biological samples might be suitable for use in the assay. Remove serum from the clot as soon as possible after clotting.

Samples containing a visible precipitate must be clarified prior to use in the assay. Do not use grossly hemolyzed or lipemic specimens.

Samples should be aliquoted and must be stored frozen at -20°C to avoid loss of bioactive human TGF-β2. If samples are to be run within 24 hours, they may be stored at 2° to 8°C.

Avoid repeated freeze-thaw cycles. Prior to assay, the frozen sample should be brought to room temperature slowly and mixed gently.

7. MATERIALS REQUIRED BUT NOT PROVIDED

- 5 ml and 10 ml graduated pipettes
- 5 µl to 1000 µl adjustable single channel micropipettes with disposable tips
- 50 µl to 300 µl adjustable multichannel micropipette with disposable tips
- Multichannel micropipette reservoir
- Beakers, flasks, cylinders necessary for preparation of reagents
- Device for delivery of wash solution (multichannel wash bottle or automatic wash system)
- Microwell strip reader capable of reading at 450 nm (620 nm as optional reference wave length)
- Glass-distilled or deionized water
- Statistical calculator with program to perform regression analysis

8. PRECAUTIONS FOR USE

- All chemicals should be considered as potentially hazardous. We therefore recommend that this product is handled only by those persons who have been trained in laboratory techniques and that it is used in accordance with the principles of good laboratory practice. Wear suitable protective clothing such as laboratory overalls, safety glasses and gloves. Care should be taken to avoid contact with skin or eyes. In the case of contact with skin or eyes wash immediately with water. See material safety data sheet(s) and/or safety statement(s) for specific advice.
- Reagents are intended for research use only and are not for use in diagnostic or therapeutic procedures.
- Do not mix or substitute reagents with those from other lots or other sources.
- Do not use kit reagents beyond expiration date on label.
- Do not expose kit reagents to strong light during storage or incubation.
- Do not pipette by mouth.
- Do not eat or smoke in areas where kit reagents or samples are handled.
- Avoid contact of skin or mucous membranes with kit reagents or specimens.
- Rubber or disposable latex gloves should be worn while handling kit reagents or specimens.
- Avoid contact of substrate solution with oxidizing agents and metal.
- Avoid splashing or generation of aerosols.
- In order to avoid microbial contamination or cross-contamination of reagents or specimens which may invalidate the test use disposable pipette tips and/or pipettes.
- Use clean, dedicated reagent trays for dispensing the conjugate and substrate reagent.
- Exposure to acid inactivates the conjugate.
- Glass-distilled water or deionized water must be used for reagent preparation.
- Substrate solution must be at room temperature prior to use.
- Decontaminate and dispose specimens and all potentially contaminated materials as they could contain infectious agents. The preferred method of decontamination is autoclaving for a minimum of 1 hour at 121.5°C.
- Liquid wastes not containing acid and neutralized waste may be mixed with sodium hypochlorite in volumes such that the final mixture contains 1.0% sodium hypochlorite. Allow 30 minutes for effective decontamination. Liquid waste containing acid must be neutralized prior to the addition of sodium hypochlorite.

9. PREPARATION OF REAGENTS

Buffer Concentrates should be brought to room temperature and should be diluted before starting the test procedure.

If crystals have formed in the **Buffer Concentrates**, warm them gently until they have completely dissolved.

9.1 Wash Buffer (1x)

Pour entire contents (30 ml) of the **Wash Buffer Concentrate** (40x) into a clean graduated cylinder. Bring to final volume of 1200 ml with glass-distilled or deionized water. Mix gently to avoid foaming. The pH of the final solution should adjust to 7.4.

Transfer to a clean wash bottle and store at 2° to 8°C. Please note that Wash Buffer (1x) is stable for 30 days.

Wash Buffer (1x) may also be prepared as needed according to the following table:

Number of Strips	Wash Buffer Concentrate (40x) (ml)	Distilled Water (ml)
1 - 6	15	585
1 - 12	30	1170

9.2 Assay Buffer (1x)

Pour the entire contents (10 ml) of the **Assay Buffer Concentrate** (10x) into a clean 100 ml graduated cylinder. Bring to final volume of 100 ml with distilled water. Mix gently to avoid foaming.

Store at 2° to 8°C. Please note that the Assay Buffer (1x) is stable for 30 days.

Assay Buffer (1x) may also be prepared as needed according to the following table:

Number of Strips	Assay Buffer Concentrate (10x) (ml)	Distilled Water (ml)
1 - 6	5.0	45.0
1 - 12	10.0	90.0

9.3 Human TGF- β 2 Standard

Label 5 tubes, one for each standard point.

S2, S3, S4, S5, S6

Then prepare 1:2 serial dilutions for the standard curve as follows:

Pipette 1 ml of Assay Buffer (1x) into each tube.

Pipette 1 ml of undiluted standard (serves as the highest standard S1, concentration of standard 1 = 1000 pg/ml) into the first tube, labelled S2, and mix (concentration of standard 2 = 500 pg/ml). Pipette 1 ml of this dilution into the second tube, labelled S3, and mix thoroughly before the next transfer. Repeat serial dilutions 3 more times thus creating the points of the standard curve ranging from 1000 to 31 pg/ml (see Figure 7).

Assay Buffer (1x) serves as blank.

Figure 7

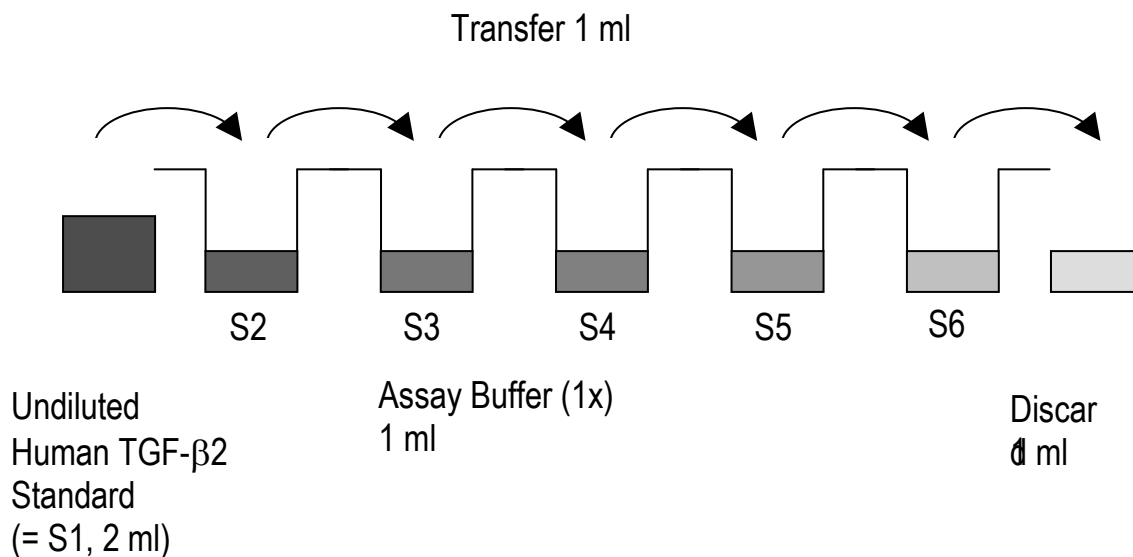

10. TEST PROTOCOL

- Predilute your samples before starting with the test procedure. Dilute serum and plasma samples 1:50 with Assay Buffer (1x) according to the following scheme: 10 μ l sample + 490 μ l Assay Buffer (1x) Dilute cell culture supernatants with Assay Buffer (1x) according to the expected human TGF- β 2 concentration
- Add 20 μ l 1N HCl to 200 μ l of prediluted samples and standards, mix and incubate for 15 minutes at room temperature. Neutralize by addition of 20 μ l 1N NaOH (check pH 7-8).
- Determine the number of microwell strips required to test the desired number of samples plus appropriate number of wells needed for running blanks and standards. Each sample, standard, blank and optional control sample should be assayed in duplicate. Remove extra microwell strips from holder and store in foil bag with the desiccant provided at 2°-8°C sealed tightly.
- Add 100 μ l of prepared and pretreated standard dilutions (S1 - S6) to the standard wells according to Table 1.

Table 1

Table depicting an example of the arrangement of blanks, standards and samples in the microwell strips:

	1	2	3	4
A	Standard 1 (1000 pg/ml)	Standard 1 (1000 pg/ml)	Sample 2	Sample 2
B	Standard 2 (500 pg/ml)	Standard 2 (500 pg/ml)	Sample 3	Sample 3
C	Standard 3 (250 pg/ml)	Standard 3 (250 pg/ml)	Sample 4	Sample 4
D	Standard 4 (125 pg/ml)	Standard 4 (125 pg/ml)	Sample 5	Sample 5
E	Standard 5 (63 pg/ml)	Standard 5 (63 pg/ml)	Sample 6	Sample 6
F	Standard 6 (31 pg/ml)	Standard 6 (31 pg/ml)	Sample 7	Sample 7
G	Blank	Blank	Sample 8	Sample 8
H	Sample 1	Sample 1	Sample 9	Sample 9

- e. Add 100 µl of **Assay Buffer (1x)** in duplicate to the **blank wells**.
- f. Add 100 µl of each prediluted and pretreated **sample** in duplicate to the **sample wells**.
- g. Cover with an adhesive film and incubate at room temperature (18 to 25°C) for 3 hours, if available on a microplate shaker set at 100 rpm. Alternatively, incubate at 2-8°C over night.
- h. Remove adhesive film and empty wells. **Wash** microwell strips 3 times with approximately 400 µl **Wash Buffer** per well with thorough aspiration of microwell contents between washes. Allow the Wash Buffer to sit in the wells for about **10 – 15 seconds** before aspiration. Take care not to scratch the surface of the microwells. After the last wash step, empty wells and tap microwell strips on absorbent pad or paper towel to remove excess Wash Buffer. Use the microwell strips immediately after washing. Alternatively microwell strips can be placed upside down on a wet absorbent paper for not longer than 15 minutes. **Do not allow wells to dry.**
- i. Add 100 µl of **Biotin-Conjugate** to all wells.
- j. Cover with an adhesive film and incubate at room temperature (18 to 25°C) for 2 hours.
- k. Remove adhesive film and empty wells. **Wash** microwell strips 3 times according to point h. of the test protocol. Proceed immediately to the next step.
- l. Add 100 µl of **Streptavidin-HRP** to all wells, including the blank wells.
- m. Cover with an adhesive film and incubate at room temperature (18° to 25°C) for 20 minutes.
- n. Remove adhesive film and empty wells. **Wash** microwell strips 3 times according to point h. of the test protocol. Proceed immediately to the next step.

- o. Pipette 100 μ l of **TMB Substrate Solution** to all wells. (A slight blue colour of the one component TMB does not interfere with the test results.)
- p. Incubate the microwell strips at room temperature (18° to 25°C) for about 15 min, if available on a rotator set at 100 rpm. Avoid direct exposure to intense light. **The colour development on the plate should be monitored and the substrate reaction stopped (see next point of this protocol) before positive wells are no longer properly recordable.**
Determination of the ideal time period for colour development has to be done individually for each assay. It is recommended to add the stop solution when the highest standard has developed a dark blue colour. Alternatively the colour development can be monitored by the ELISA reader at 620 nm. The substrate reaction should be stopped as soon as Standard 1 has reached an OD of 0.60 – 0.65.
- q. Stop the enzyme reaction by quickly pipetting 50 μ l of **Stop Solution** into each well. It is important that the Stop Solution is spread quickly and uniformly throughout the microwells to completely inactivate the enzyme. Results must be read immediately after the Stop Solution is added or within one hour if the microwell strips are stored at 2 - 8°C in the dark.
- r. Read absorbance of each microwell on a spectro-photometer using 450 nm as the primary wave length (optionally 620 nm as the reference wave length; 610 nm to 650 nm is acceptable). Blank the plate reader according to the manufacturer's instructions by using the blank wells. Determine the absorbance of both the samples and the standards.

Note: In case of incubation without shaking the obtained O.D. values may be lower than indicated below. Nevertheless the results are still valid.

11. CALCULATION OF RESULTS

- Calculate the average absorbance values for each set of duplicate standards and samples. Duplicates should be within 20 per cent of the mean value.
 Create a standard curve by plotting the mean absorbance for each standard concentration on the ordinate against the human TGF- β 2 concentration on the abscissa. Draw a best fit curve through the points of the graph (a 5-parameter curve fit is recommended).
 To determine the concentration of circulating human TGF- β 2 for each sample, first find the mean absorbance value on the ordinate and extend a horizontal line to the standard curve. At the point of intersection, extend a vertical line to the abscissa and read the corresponding human TGF- β 2 concentration.
- **If instructions in this protocol have been followed serum and plasma samples have been diluted 1:50, the concentration read from the standard curve must be multiplied by the dilution factor (x 50).**

It is suggested that each testing facility establishes a control sample of known human TGF- β 2 concentration and runs this additional control with each assay. If the values obtained are not within the expected range of the control, the assay results may be invalid.

- A representative standard curve is shown in Figure 8. This curve cannot be used to derive test results. Each laboratory must prepare a standard curve for each group of microwell strips assayed.

Figure 8

Representative standard curve for human TGF- β 2 ELISA. Human TGF- β 2 was diluted in serial 2-fold steps in Assay Buffer (1x). Do not use this standard curve to derive test results. A standard curve must be run for each group of microwell strips assayed.

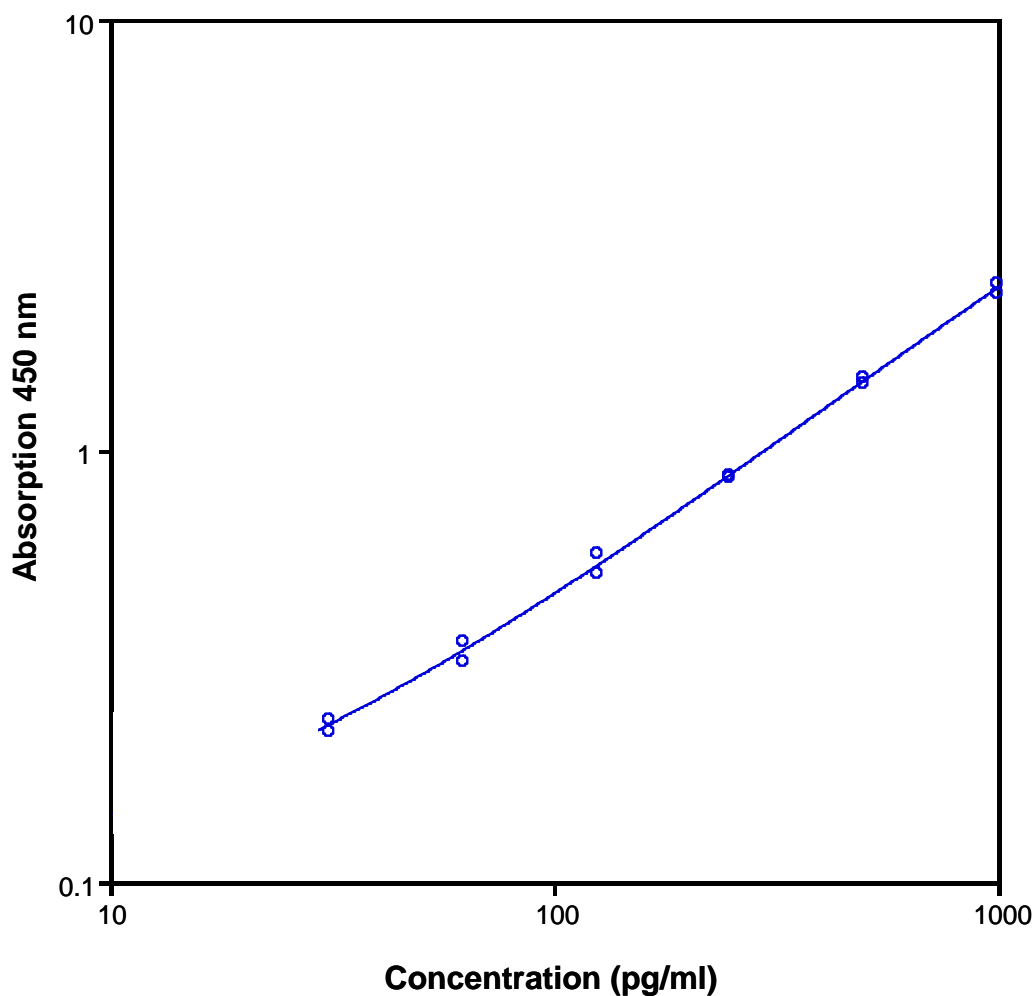

Table 2

Typical data using the human TGF- β 2 ELISA

Measuring wavelength: 450 nm

Reference wavelength: 620 nm

Standard	Human TGF- β 2 Concentration (pg/ml)	O.D. at 450 nm	Mean O.D. at 450 nm	C.V.(%)
1	1000	2.323	2.386	2.6
	1000	2.448		
2	500	1.431	1.457	1.8
	500	1.483		
3	250	0.874	0.872	0.2
	250	0.870		
4	125	0.521	0.548	5.0
	125	0.576		
5	63	0.325	0.342	5.0
	63	0.360		
6	31	0.224	0.231	2.8
	31	0.237		
Blank	0	0.124	0.127	
	0	0.130		

The OD values of the standard curve may vary according to the conditions of assay performance (e.g. operator, pipetting technique, washing technique or temperature effects). Furthermore shelf life of the kit may affect enzymatic activity and thus colour intensity. Values measured are still valid.

12. LIMITATIONS

- Since exact conditions may vary from assay to assay, a standard curve must be established for every run.
- Bacterial or fungal contamination of either screen samples or reagents or cross-contamination between reagents may cause erroneous results.
- Disposable pipette tips, flasks or glassware are preferred, reusable glassware must be washed and thoroughly rinsed of all detergents before use.
- Improper or insufficient washing at any stage of the procedure will result in either false positive or false negative results. Empty wells completely before dispensing fresh wash solution, fill with Wash Buffer as indicated for each wash cycle and do not allow wells to sit uncovered or dry for extended periods.
- The use of radioimmunotherapy has significantly increased the number of patients with human anti-mouse IgG antibodies (HAMA). HAMA may interfere with assays utilizing murine monoclonal antibodies leading to both false positive and false negative results. Serum samples containing antibodies to murine immunoglobulins can still be analysed in such assays when murine immunoglobulins (serum, ascitic fluid, or monoclonal antibodies of irrelevant specificity) are added to the sample.

13. PERFORMANCE CHARACTERISTICS

13.1 Sensitivity

The limit of detection of human TGF- β 2 defined as the analyte concentration resulting in an absorbance significantly higher than that of the dilution medium (mean plus 2 standard deviations) was determined to be 6.6 pg/ml (mean of 6 independent assays).

13.2 Reproducibility

13.2.1 Intra-assay

Reproducibility within the assay was evaluated with 8 replicates of 3 samples containing different concentrations of human TGF- β 2. The calculated overall intra-assay coefficient of variation was < 10%.

13.2.2 Inter-assay

Assay to assay reproducibility within one laboratory was evaluated with 12 replicates of 3 samples containing different concentrations of human TGF- β 2. The calculated overall inter-assay coefficient of variation was < 10%.

13.3 Spiking Recovery

The spiking recovery was evaluated by spiking different levels of human TGF- β 2 into various samples. The overall mean recovery was > 90%.

13.4 Specificity

The interference of circulating factors of the immune system was evaluated by spiking these proteins at physiologically relevant concentrations into a human TGF- β 2 positive serum. There was no crossreactivity detected, notably not with human TGF- β 1 and human TGF- β 3.

14. REFERENCES

1. Constam DB, Schmid P, Aguzzi A, Schachner M, Fontana A. Transient production of TGF- β 2 by postnatal cerebellar neurons and its effect on neuroblast proliferation. *Eur J Neurosci* 1994 May 1;6(5):766-78.
2. Gupta A, Monroy D, Ji Z, Yoshino K, Huang A, Pflugfelder SC. Transforming growth factor beta-1 and beta-2 in human tear fluid. *Curr Eye Res* 1996 Jun;15(6):605-14.
3. Hirase K, Ikeda T, Sotenza C, Nishida K, Sawa H, Kinoshita S. Transforming growth factor beta2 in the vitreous in proliferative diabetic retinopathy. *Arch Ophthalmol* 1998 Jun;116(6):738-41.
4. Hu DN, McCormick SA, Lin AY, Lin JY. TGF- β 2 inhibits growth of uveal melanocytes at physiological concentrations. *Exp Eye Res* 1998 Aug;67(2):143.
5. Krasagakis K, Tholke D, Farthmann B, Eberle J, Mansmann U, Orfanos CE. Elevated plasma levels of transforming growth factor (TGF)-beta1 and TGF-beta2 in patients with disseminated malignant melanoma. *Br J Cancer* 1998 May;77(9):1492-4.
6. Kropf J, JO Schurek, A Wollner, and AM Gressner. Immunological measurement of transforming growth factor-beta I (TGF- β 1) in blood; assay development and comparison. *Clinical Chemistry* 1997;43(10):1965-1974.
7. Lawrence DA. Transforming growth factor-beta: a general review. *Eur Cytokine Netw* 1996 Sep;7(3):363-374.
8. Olaso R, Pairault C, Boulogne B, Durand P, Habert R. Transforming growth factor beta1 and beta2 reduce the number of gonocytes by increasing apoptosis. *Endocrinology* 1998 Feb;139(2):733-40.
9. Sanford LP, Ormsby I, Gittenberger-de Groot AC, Sariola H, Friedman R, Boivin GP, Cardell EL, Doetschman T. TGF- β 2 knockout mice have multiple developmental defects that are non-overlapping with other TGFbeta knockout phenotypes. *Development* 1997 Jul; 124(13):2659-70.
10. Vawter MP, Dillon-Carter O, Tourtellotte WW, Carvey P, Freed WJ. TGFbeta1 and TGFbeta2 concentrations are elevated in Parkinson's disease in ventricular cerebrospinal fluid. *Exp Neurol* 1996 Dec;142(2):313-22.

15. REAGENT PREPARATION SUMMARY

15.1 Wash Buffer (1x)

Add **Wash Buffer Concentrate** 40x (30 ml) to 1200 ml distilled water.

Number of Strips	Wash Buffer Concentrate (ml)	Distilled Water (ml)
1 - 6	15	585
1 - 12	30	1170

15.2 Assay Buffer (1x)

Add **Assay Buffer Concentrate** 10x (10 ml) to 90 ml distilled water.

Number of Strips	Assay Buffer Concentrate (ml)	Distilled Water (ml)
1 - 6	5.0	45.0
1 - 12	10.0	90.0

15.3 Human TGF- β 2 Standard

Prepare serial dilutions of the concentrated **human TGF- β 2 standard** in Assay Buffer (1x).

16. TEST PROTOCOL SUMMARY

1. Predilute serum and plasma samples with Assay Buffer (1x) 1:50.
2. Pretreat samples and standards with HCl and NaOH.
3. Determine the number of microwell strips required.
4. Add 100 µl of the pretreated standard dilutions in duplicate to the designated standard wells.
5. Add 100 µl Assay Buffer (1x), in duplicate, to the blank wells.
6. Add 100 µl prediluted and pretreated sample in duplicate to designated sample wells.
7. Cover microwell strips and incubate 3 hours at room temperature (18° to 25°C), alternatively at 2-8°C over night.
8. Empty and wash microwell strips 3 times with Wash Buffer.
9. Add 100 µl Biotin-Conjugate to all wells.
10. Cover microwell strips and incubate 2 hours at room temperature (18° to 25°C).
11. Empty and wash microwell strips 3 times with Wash Buffer.
12. Add 100 µl Streptavidin-HRP to all wells.
13. Cover microwell strips and incubate 20 minutes at room temperature (18° to 25°C).
14. Empty and wash microwell strips 3 times with Wash Buffer.
15. Add 100 µl of TMB Substrate Solution to all wells.
16. Incubate the microwell strips for about 15 minutes at room temperature (18° to 25°C).
17. Add 50 µl Stop Solution to all wells.
18. Blank microwell reader and measure colour intensity at 450 nm.

Note: If instructions in this protocol have been followed serum and plasma samples have been diluted 1:50, the concentration read from the standard curve must be multiplied by the dilution factor (x 50).

NOTES



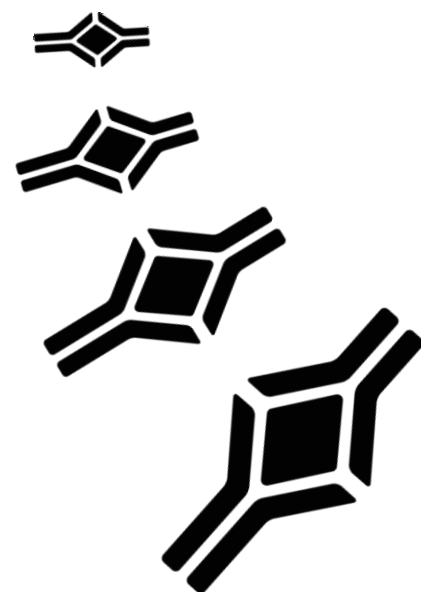

Gentaur Molecular Products
Voortstraat 49
1910 Kampenhout, Belgium
<http://www.gentaur-worldwide.com>